

Varenummer: 0106049  
 Beskrivelse: Seeger låsering JV 32

## Mål

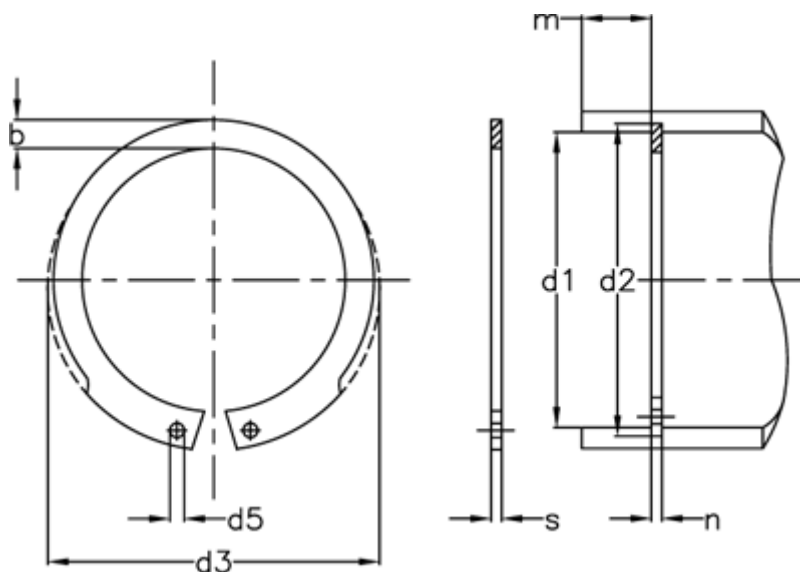

AN mm <sup>2</sup>	= 42	FRg kN	= 4.9	Tang	= ZGJ-1
b	= 3.3	FR kN	= 14.1	tol	= -0.06
Betegnelse	= JV 32	g	= 1.0	tol	= +0,50-0,25
d1	= 32	K kN-mm	= 27.4	tol	= +0,25
d2	= 33.7	m min	= 1.30	tol	= 0.1
d3	= 34.4	Nominel træk	= 2.5	vægt kg/1000	= 2.05
d5 min	= 1.5	s	= 1.20		
FN kN	= 7.00	t	= 0.85		